

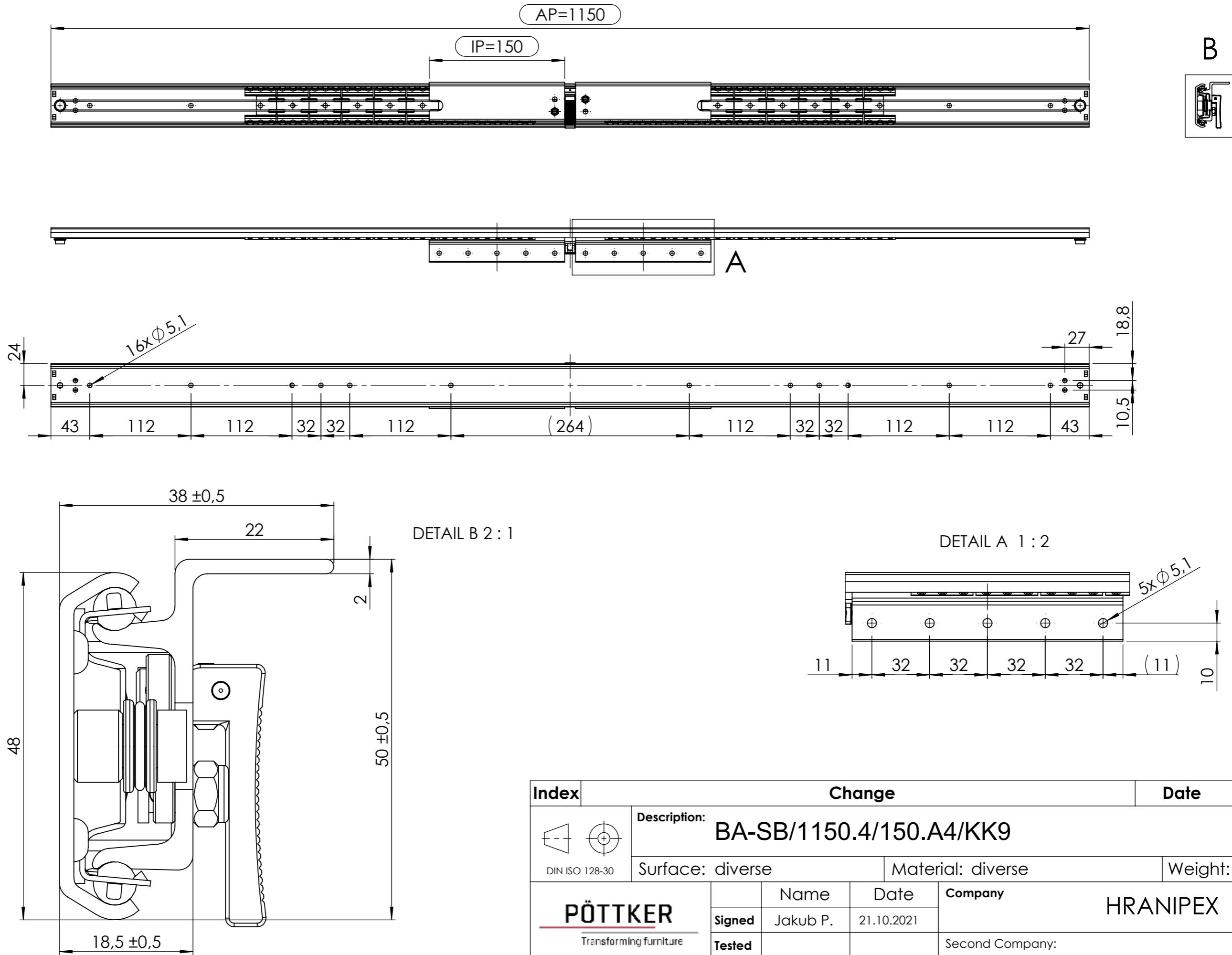

All property rights and rights to exploitation of copyright for this drawing data remain ours; they may not be made available to third parties without our consent.

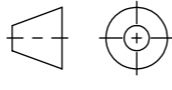

opening : ca. **838** mm

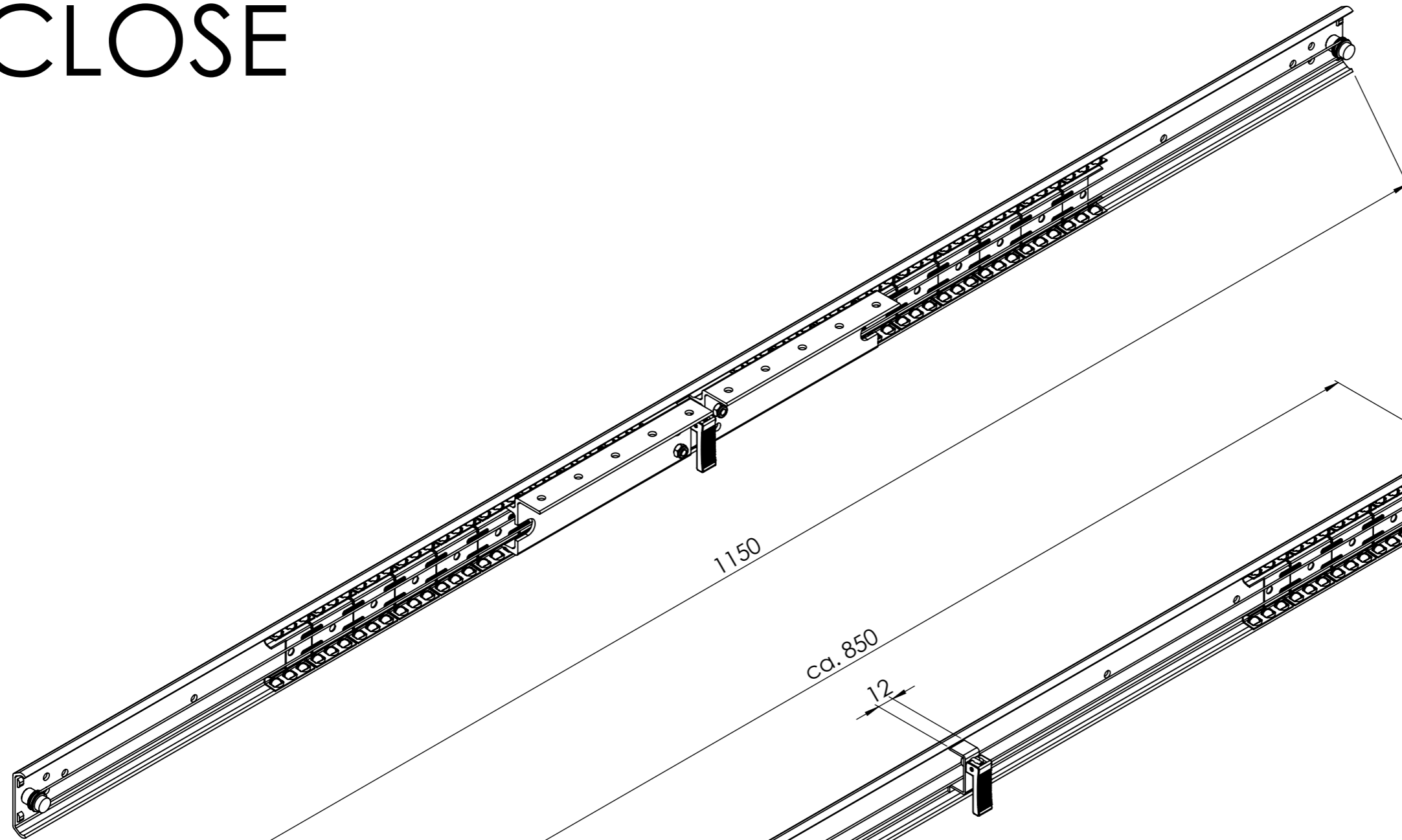

Index	Change			Date	Name
 DIN ISO 128-30	Description: <b>BA-SB/1150.4/150.A4/KK9</b>				
	Surface: diverse		Material: diverse		Weight: 1.61 kg
 Transforming furniture	Name	Date	Company		
	Signed	Jakub P.	21.10.2021	HRANIPEX	
	Tested			Second Company:	
General tolerance: DIN ISO 2768 - m		Item No:	<b>47115901</b>	Scale 1:4	Page 1/3
					<b>A3</b>

# CLOSE

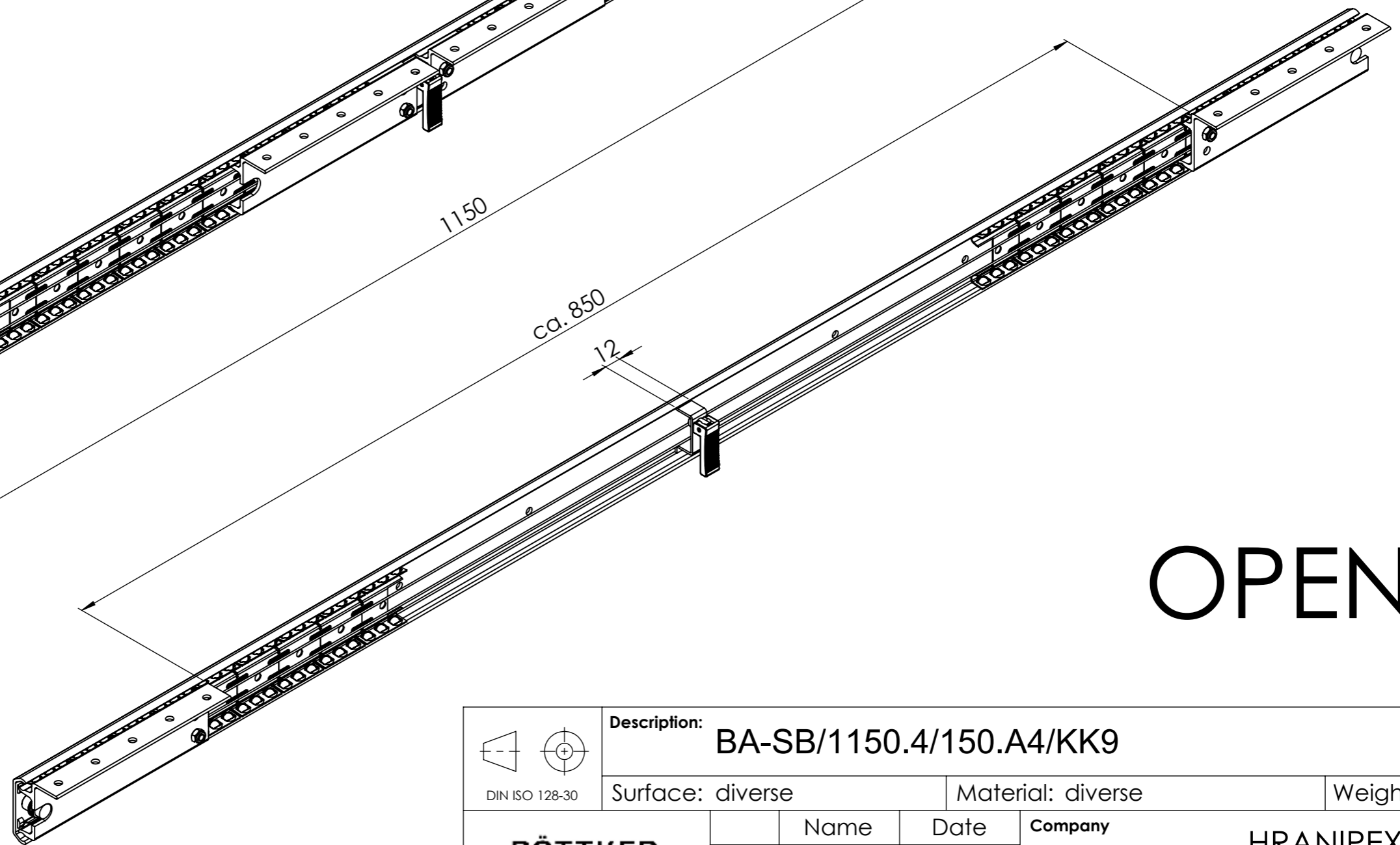

# OPEN

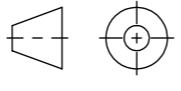

 DIN ISO 128-30	<b>Description:</b> BA-SB/1150.4/150.A4/KK9					
	Surface: diverse		Material: diverse		Weight: 1.61 kg	
 Transforming furniture	<b>Name</b>	<b>Date</b>	<b>Company</b>			
	Signed: Jakub P.	21.10.2021	HRANIPEX			
	Tested:	(empty)	Second Company:			
General tolerance: DIN ISO 2768 - m		Item No:	<b>47115901</b>	Scale 1:3	Page 2/3	<b>A3</b>

All property rights and rights to exploitation of copyright for this drawing data remain ours; they may not be made available to third parties without our consent.